



TDFM-9000

MULTIBAND P25 AIRBORNE TRANSCEIVER



Operating Instructions

TiL Document No. 11RE441

Rev. H

SEPTEMBER 2022

Technisonic Industries Limited

240 Traders Boulevard, Mississauga, Ontario L4Z 1W7
Tel: (905) 890-2113 Fax: (905) 890-5338
www.til.ca

Copyright by Technisonic Industries Limited. All rights reserved.

TECHNISONIC INDUSTRIES LIMITED

REVISION HISTORY [11RE441]				
For the most current revision of this document, please check the Technisonic website: www.til.ca				
REV	PAGE	DESCRIPTION	DATE	EDITED BY
A	Front Page	Replaced TDFM-9000 Photo with Current Picture.	Aug. 13, 2013	SM
B	12	Document Now References Correct TIB.	Oct. 29, 2013	AL
	13	Programming and Keyloading Cables Corrected.		
C	iv	Changed STC Approval Note.	May 12, 2014	AL
	2	Added Special Order Band Codes.		
	8	Corrected Mislabeled Section Reference Number.		
	All	Changed Format for Section Headers.		
D	8	Updated CBR info with RBC.	Nov. 03, 2014	JR
	14	Updated Configuration Menu info.		
	17	Added Talkgroup ID Programming to FPP info.		
E	2	Updated Module Nomenclature Table for T4000.	Jul. 04, 2016	JR
	11 & 15	Section 2.11 & 2.17: Added info on ADM.		
	15	Section 2.17: Added User Mode info regarding Dual User Lock.		
F	i	Added Website Information to Revision Page.	Aug. 28, 2017	AL
	19	Added Warranty Page.		
	All	Page Numbers are now sequential.		
	All	Changed Format for 'Notes.'		
	All	Corrected Spelling & Grammar throughout document.		
G	3	Section 1.4: Added Storage Temperature.	Oct. 25, 2019	AL
	20-23	Sections 2.20-2.22 added for MOD 14 changes: Added information regarding S200-P12 Satcom Control and External Transceivers.		
	1, 6, 11, 15 & 16	Sections 1.2, 2.5, 2.15, and 2.17: MOD 14 information added.		
H	1, 8	Added Info on ASU-9000	Sept. 16, 2022	JR

This page is intentionally left blank.

NOTES

CAUTION! STATIC SENSITIVE !



This unit contains static sensitive devices. Wear a grounded wrist strap and/or conductive gloves when handling printed circuit boards.

FCC COMPLIANCE INFORMATION

This device complies with Part 15 of the FCC Rules. Operation is subject to the following two conditions: (1) this device may not cause harmful interference and (2) this device must accept any interference received, including interference that may cause undesired operation.



WARNING: For compliance with FCC RF Exposure Requirements the mobile transmitter antenna installation shall comply with the following two conditions:

1. The transmitter antenna gain shall not exceed 3 dBi.
2. The transmitter antennas shall be located outside of a vehicle and must not be co-located (kept at a separation distance of more than 20cm from each other when installed). Also they must be installed in such a way that they always maintain a separation distance of more than 90 cm from any person during operation.

NOTE: This equipment has been tested and found to comply with the limits for a Class A digital device, pursuant to Part 15 of the FCC Rules. These limits are designed to provide reasonable protection against harmful interference when the equipment is operated in a commercial environment. This equipment generates, uses, and can radiate radio frequency energy and, if not installed and used in accordance with the instruction manual, may cause harmful interference to radio communications. Operation of this equipment in a residential area is likely to cause harmful interference, in which case the user will be required to correct the interference at his/her own expense.

WARNING

Changes or modifications not expressly approved by Technisonic Industries could void the user's authority to operate the equipment.

WARRANTY INFORMATION

The Model TDFM-9000 Transceiver is under warranty for one year from date of purchase. Failed units caused by defective parts or workmanship should be returned to:

Technisonic Industries Limited
240 Traders Boulevard
Mississauga, Ontario L4Z 1W7

Tel: (905) 890-2113
Fax: (905) 890-5338

TECHNISONIC INDUSTRIES LIMITED

SUMMARY OF DO-160G ENVIRONMENTAL TESTING

Summary of DO-160G Environmental Testing for Technisonic Model TDFM-9000 Transceiver:

CONDITIONS	CATEGORY
Temperature and Altitude	A2, B1, C4, D1
Temperature Variation	B
Humidity	A
Operational Shock and Crash Safety	A
Vibration	S, U
Magnetic Effect	Z
Power Input	B
Voltage Spike	B
Audio Frequency Susceptibility	B
Induced Signal Susceptibility	AC
Radio Frequency Susceptibility	T
Radio Frequency Emission	M
Electrostatic Discharge	A

STC APPROVAL NOTE

Presently, no TSO standard exists for airborne FM transceivers. To make it easier for installation agencies to provide their customers with an approved installation supported by an effective Airworthiness Approval, Technisonic has secured Supplemental Type Certificate (STC) approval. The above referenced DO-160G test data is also on file and available from Technisonic to support approval requirements in airframes for which Technisonic does not possess an STC.

Approved aircraft types are listed in the attachments to the formal STC documents. These STCs are the exclusive property of Technisonic and require the written authority of Technisonic for their use. To assist Factory Authorized Technisonic Dealers in the certification process, we have placed copies of our Canadian and US STCs on our website along with a letter of authorization for their use. These documents may be downloaded and used as support for the technical submission to FAA or Transport Canada. Only authorized factory dealers/installers are permitted to download and make use of these documents on behalf of their customers (end users) in support of regulatory agency approval. Please refer to the Technisonic website www.til.ca for the latest issue of available STCs and letter of authorization for use.

WARNING AND DISCLAIMER

This manual is designed to provide information about the TDFM-9000. Every effort has been made to make this manual as complete and accurate as possible.

TRADEMARK NOTICES

TDFM-9000 Transceivers contain two-way radio protocols licensed from Motorola, Inc.
© 1997, 1998 Motorola, Inc.

TABLE OF CONTENTS

SECTION	TITLE	PAGE
1.1	INTRODUCTION	1
1.2	DESCRIPTION	1
1.3	MODEL VARIATION	1
1.4	TECHNICAL CHARACTERISTICS	3
2.1	GENERAL	5
2.2	FRONT PANEL	5
2.3	POWER SWITCH	6
2.4	KNOB	6
2.5	SOFT KEYS AND HOME	6
2.6	MODE KEY	7
2.7	FUNC KEY	7
2.8	F1 to F4 KEYS	8
2.9	MUP(4) AND MDN(7) KEYS (Memory Up and Down Keys)	10
2.10	UP(5) AND DOWN(8) KEYS	10
2.11	BRT(6) AND DIM(9) KEYS	11
2.12	ESW(0) KEY (Ergo Switch Key)	11
2.13	TSW(*) KEY (Toggle Switch Key)	11
2.14	DISPLAY	11
2.15	GENERAL OPERATION	11
2.16	CUSTOMER PROGRAMMING SOFTWARE (APX CPS)	12
2.17	CONFIGURATION MENU	14
2.18	KEYLOADING MODE	16
2.19	FRONT PANEL PROGRAMMING (FPP) MODE	17
2.20	LATITUDE S200-P12 SATCOM CONTROL.....	20
2.21	LATITUDE S200-P12 PTT MODE	20
2.22	LATITUDE S200-P12 PHONE MODE	22
	WARRANTY	24

LIST OF FIGURES

FIGURE	TITLE	PAGE
1	Front Panel Controls – TDFM-9000 Transceiver	5
2	Programming Cable: P/N 127499	13
3	Encryption Keyloading Cable: P/N 127500	13

LIST OF TABLES

TABLE	TITLE	PAGE
1	TDFM 9000 Series TPL (CTCSS) Codes	19
2	TDFM 9000 Series DPL (DCS) Codes	19

This page is intentionally left blank.

SECTION 1: GENERAL DESCRIPTION

1.1 INTRODUCTION

This publication provides operating information on the TDFM-9000 airborne transceiver. The exact configuration depends on which and how many RF modules are installed.

NOTE: This publication supports radios with Version 2.0.0 or higher software.

1.2 DESCRIPTION

The TDFM-9000 transceiver is an airborne multi-band radio capable of operation in conventional, analog, P25 and P25 phase II digital FM systems, SmartNet/SmartZone trunking systems, and P25 9600 trunking systems. RF modules are available in single, dual, or Tri bands that support VHF, UHF-LO, UHF-HI, and 700-800 MHz bands. Up to 6 single or multiple band modules can be supported.

These optional additional features include P25 9600 trunking Phase 1 and 2 that may be combined with AES and/or DES-OFB encryption with OTAR in any of the available modules.

The TDFM-9000 is not normally frequency agile. In order to have the ability to change the frequencies at the front panel, the FPP (front panel programming) option must be ordered for each band. FPP is available on all bands of modules.

TDFM-9000 transceivers with MOD 14 (MCP) have the capability to provide PTT, mic, and headset audio for up to 2 (Bands 7 and 8) remote handheld transceivers and/or a Latitude Technologies S200-P12 Satphone / PTT network COM transceiver. Front panel control of the S200-P12 is provided via the display and keypad. Connector J9 provides the MOD 14 interface. See Table 5 for a list of recommended interface cables for various hand-held transceivers. A digital audio port has been added to interface with the Technisonic TDAP-650 and TDAP-750 digital audio panels.

Radios equipped with SW V2.7.0, or higher, supports connection to optional Antenna Switching Unit ASU-9000 for Forestry operations.

1.3 MODEL VARIATION

There are several variations of the Model TDFM-9000 Transceiver. Each variation offers different features and performance based on the type of RF modules and options installed.

RF Modules are mounted in trays of two (with up to 3 trays supported).
The following is a breakdown of the TDFM-9000 model variations:

P/N 101263-D-90-TBB-TBB-TBB-P9XXXX

(PRODUCT TYPE)-(D)-(9X)-(Tray 1)-(Tray2)-(Tray3)-(Project)

PRODUCT TYPE:	101263 = TDFM-9000 Series, 3 trays	Tray1: P25, Tray2: P25, Tray :3 P25
DISPLAY TYPE (D):	1: COLOR 2: COLOR/ NV	
SERIES VARIANT(9X)	90 = TDFM-9000	
TRAY BREAKDOWN (TBB)	T = Tray Module Type: A = Digital Modules	B = Module Band Code (See the following tables for supported configurations)
PROJECT NUMBER	This is a unique number that describes the specific build of the radio	

TECHNISONIC INDUSTRIES LIMITED

	DUAL BAND MODULES (T30xx)			TRI BAND MODULES (T4000)			
SINGLE BAND	1	VHF		5	VHF		
	2	UHF LO		6	UHF LO		
	3	UHF HI		7	UHF HI		
	4	700/800		8	700/800		
DUAL BAND	A	VHF	700/800	M	VHF	700/800	
	B	VHF	UHF LO	N	VHF	UHF LO	
	C	VHF	UHF HI	P	VHF	UHF HI	
	D	UHF LO	UHF HI	R	UHF LO	UHF HI	
	E	UHF LO	700/800	T	UHF LO	700/800	
	F	UHF HI	700/800	V	UHF HI	700/800	
	* G	700/800	VHF	-			
	* H	700/800	UHF LO	-			
	* I	700/800	UHF HI	-			
	* J	UHF LO	VHF	-			
	* K	UHF HI	VHF	-			
	* L	UHF HI	UHF LO	-			
TRI BAND	-			W	VHF	UHF LO	UHF HI
	-			X	UHF LO	UHF HI	700/800
	-			\$ Z	VHF	UHF	700/800

TYPE A Module Band Codes

BAND	FREQUENCY RANGE
VHF	136 – 174 MHz
UHF LO	380 – 470 MHz
UHF HI	450 – 520 MHz
700/800	764 – 870 MHz
UHF	380 – 520 MHz

RF Band Coverage

Band numbers indicate Single band equipped modules and letters indicate Dual or Tri band modules.

* Band codes are special order and are not standard configuration.

\$ UHF Band specified covers both the UHF LO and UHF HI as one band. (380 – 520 MHz).

Project Number: P9XXXX represents a 5-digit project number that identifies specific options that are contained in each module and describes the full TDFM-9000 configuration.

All model variations are capable of supporting both 28 volt and 5 volt AC or DC backlighting. The units are shipped set to operate on 28 volt backlighting. Equipment can be set to operate on 5 V backlighting by using the software based configuration menu. See Section 2.17 Configuration Menu. Damage will not occur if the incorrect voltage is applied.

TECHNISONIC INDUSTRIES LIMITED

1.4 TECHNICAL CHARACTERISTICS

<u>Specification</u>	<u>Characteristic</u>
Model Designation:	TDFM-9000
Physical Dimensions:	Approx. (L) 8.0" x (W) 5.75" x (H) 4.5"
Weight:	~7.0 Lbs (3.2 Kg)
Operating Temperature Range:	-30° C to +60° C
Storage Temperature:	-40° C to +80° C
Power Requirement:	
Voltage:	28.0 V _{DC} ± 15%
Current:	500 mA minimum / 7.5A maximum
Audio Output Power (including sidetone):	65 mW into 600 Ω
Microphone Inputs:	Carbon or Equivalent
Panel Backlighting:	
Voltage:	28 or 5 Volts AC or DC (selectable)
Current:	100 mA

RF Modules

<u>Specification</u>	<u>Characteristic</u>
RF Output Power:	1 or 6 Watts (VHF) 1 or 5 Watts (UHF) 1 or 2.5 watts (764 - 806) 1 or 3 Watts (806 -870)
Frequency Range	
VHF Band:	136 to 174 MHz
UHF LO Band:	380 to 470 MHz
UHF HI Band:	450 to 520 MHz
UHF Band:	380 to 520 MHz
700 / 800 bands:	764 to 870 MHz
No. of channels per band:	3000 pre-programmable channels

Transmitter section

	VHF	UHF	800
FM Hum and noise in dB (wideband):	-48	-45	-45
Audio Distortion:	1.0%	1.0%	1.0%
Frequency Stability in ppm:	± 1.0	± 1.0	± 1.5
Modulation Limiting:	Wide band	± 5 kHz	
	Narrow band	± 2.5 kHz	

Receiver section

	VHF	UHF	800
<i>Sensitivity</i> in uV:			
* Digital 1% BER (12.5 kHz)	0.29	0.32	0.40
* Digital 5% BER (12.5 kHz)	0.21	0.28	0.30
** Analog with 12 dB SINAD	0.25	0.25	0.25
<i>Selectivity</i> in dB:			
25 kHz Channel	-80	-78	-72
12.5 kHz Channel	-70	-68	-67
Intermodulation * **	-80	-80	-80

* Measured in digital mode per TIA / EIA IS 102.CAAA under nominal conditions.

** Measured in analog mode per TIA / EIA 603 under nominal conditions.

This page is intentionally left blank.

SECTION 2: OPERATING INSTRUCTIONS

2.1 GENERAL

A colour LCD display, a keypad, and a rotary knob provide the operator control of up to 6 RF modules installed in the unit. The display shows the activity of all 6 modules as well as the soft key menu of the active band. The active module is selected by pressing the corresponding soft key on the left of the display. The knob has multiple functions including volume and channel. The microphone, key line, and headphone audio can be wired separately for each of the 6 modules; therefore, switching from band to band is performed at an audio panel such as the Technisonic A71X series. This allows for separate and simultaneous operation on each of the bands (just like having 6 separate radios). The transceiver can also be connected so that all bands are available on one of the combined outputs. In this configuration, the soft keys on the transceiver provide the audio panel function. It is possible to connect the transceiver such that both methods are used.

2.2 FRONT PANEL

Refer to the diagram below:

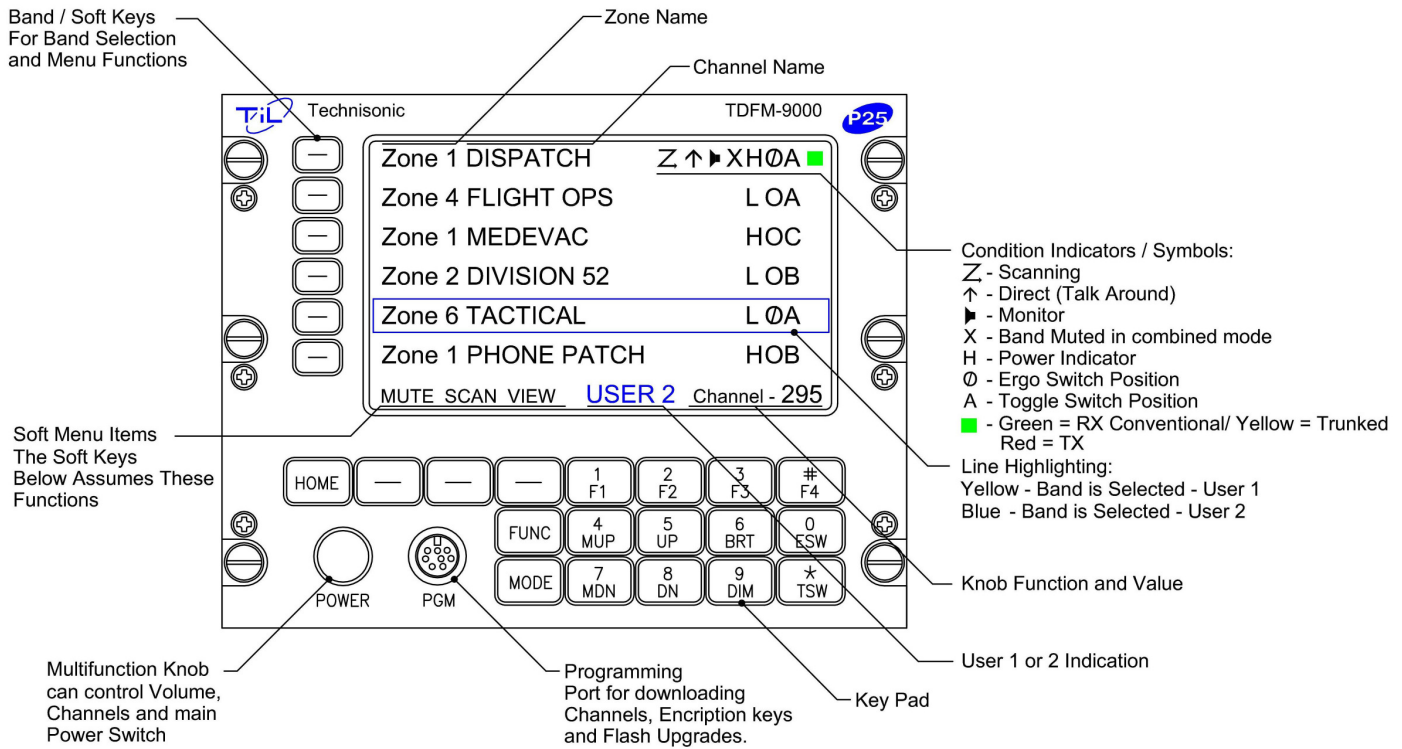

FIGURE 1: Front Panel Controls – TDFM-9000 Transceiver

2.3 POWER SWITCH

To switch the transceiver on, press and hold the knob until the radio powers up. The display will show TECHNISONIC and the software version installed followed by the model number along with which RF modules are installed. The display will then show the normal display. To switch off the transceiver at any time, press and hold the knob for 2 seconds until the display shows OFF and then release. If it is desired that the radio powers up with the radio master in the aircraft, an 'always on' mode can be set in the configuration menu.

2.4 KNOB

The knob is a rotary encoder, which turns endlessly. The knob also has a push button incorporated in it so you can press the knob as well as turn it. The knob will start out as a volume control. Pressing the knob again will change its function to act as the channel selector. Another knob press will bring you to the recall mode. In the recall mode, typing in a Zone and Channel number will bring you quickly to that channel without scrolling through many channels. Pressing the knob again brings it back to the volume control mode. The current function of the knob is shown at the bottom right of the display.

2.5 SOFT KEYS AND HOME

The transceiver has nine soft keys. The 3 soft keys below the display assume the function shown on the menu above them. The functions displayed depend on how the module was programmed with the customer programming software (APX CPS)TM. These menu items can be different on a channel by channel basis. Typical menu items may include:

<i>ZONE</i>	Pressing this function will prompt you for a new zone number which can be entered directly (if the keypad is in NUM LOCK mode) or scrolled using the UP(5) and DN(8) keys.
<i>MUTE</i>	Selecting this function will prompt you for an on or off entry using the soft keys to mute the tones. Tones refer to the beeps heard when pressing buttons.
<i>PWR</i>	Selecting PWR will allow the power output of the radio to be set to high or low.
<i>VIEW</i>	The view function is used to view lists. Lists can include scan lists, phone numbers, call lists, and/or paging.
<i>FPP</i>	Front Panel Programming mode allows you to program at the front panel without the customer programming software. This option is available on all standard modules.

At any time while in one of these functions, you can escape back to the normal mode by pressing the HOME key. When programming the modules with the CPSTM, it is suggested not to double up functions. For example, programming a soft key to CHAN would be redundant since there is already a channel function using the knob.

The soft keys to the left of the display are used to select the active band for which the knob and keyboard will control. If the radio is connected using the one or both of the combined inputs, the selected band will also be selected for transmit. If you press a key on a band that is already selected, the receive audio will be toggled off and on. This can be useful to temporarily mute distracting traffic.

For MOD 14 Radios, the bottom side Menu button is used to toggle the Main display from Page 1 to Page 2 when the external transceivers or S200-P12 are enabled. Pressing and holding for one second will toggle the page.

2.6 MODE KEY

This button selects USER 1 or USER 2 mode when the unit is installed with both combined input/outputs connected. USER 1 or 2 will be indicated at the bottom of the display, and the selected band box will show yellow for USER 1 and blue for USER 2.

2.7 FUNC KEY

Pressing the FUNC key will bring up the first functions menu:

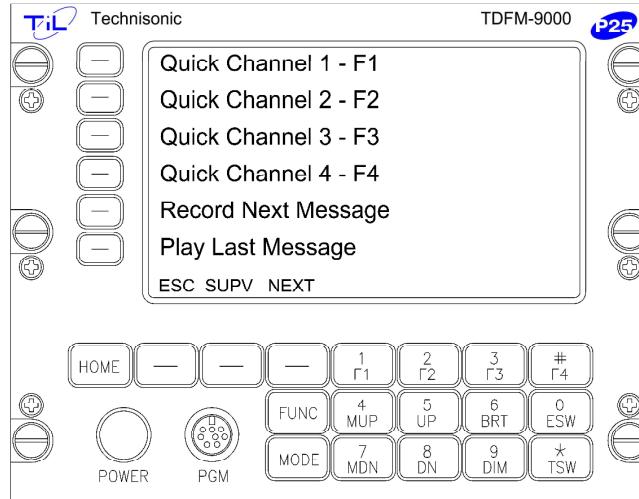

Quick Channels

Pressing one of the side menu keys or F1-F4 keys will load a pre-programmed channel.

Record Next Message

Pressing this menu key will cause the transceiver to record the next message received on the selected band.

Play Last Message

Pressing this menu key will play the last message recorded.

After selecting one of the above the radio will return to normal operating mode. Pressing the ESC soft key will return to normal operating mode without making any changes. Pressing the NEXT soft key will bring up the second function menu.

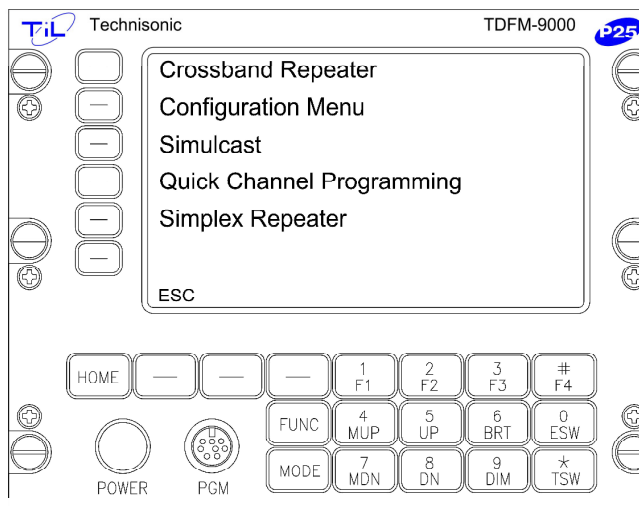

TECHNISONIC INDUSTRIES LIMITED

<i>Cross Band Repeat</i>	<p>You can select any two bands to cross band repeat. The repeat function is semi-duplex. This means the TDFM-9000 will retransmit from one band to another in both directions but not simultaneously.</p> <p>Once enabled, the Repeater Broadcast (RBC) is also enabled by default. If the radio is keyed from the either combined inputs, then Cross Band Repeat (CBR) is suspended and both bands are keyed so that a simulcast broadcast can be made. Once unkeyed, the CBR will resume after 3 seconds.</p>
<i>Configuration</i>	<p>Enters the Configuration menu (see Section 2.17 Configuration Menu). This is the same menu that can be invoked during boot up.</p>
<i>Simulcast</i>	<p>You can select 2 or more bands to transmit simultaneously. Simulcast is only available when using the one or both of the combined input/outputs. Simulcast can be used in conjunction with the cross band repeat mode.</p>
<i>Quick Channel Programming</i>	<p>Allows you to program a Hot Memory (zone/channel) to the F1 to F4 keys for each band.</p>
<i>Simplex Repeat</i>	<p>When turned on, the band selected will become a simplex repeater. Simplex repeat (sometimes called parrot repeat) will record an incoming message and immediately retransmit the message on the same frequency.</p>
<i>SUPV Soft Key</i>	<p>This key accesses the Supervisor Menu. This menu is password protected. Supervisor Menu is used to limit user access to some or all of the advanced features in the Function Menus. It also allows access to some other advance features such as Forestry Mode that supports the ASU-9000 Antenna Switching Unit. Refer to TIL Manuals 22RE631 & 22RE632 Operating and Install Instructions respectively for further details.</p>

Pressing the ESC soft key or the FUNC key will return the radio to normal operating mode without making any changes.

NOTE: Some or all of the above features may be disabled via the Supervisor Menu. Consult TIL or the local Sysop for changes to the enhanced features that are restricted.

2.8 F1 to F4 KEYS

Four function keys at the top of the keypad (when not programmed for quick channels as mentioned above) provide the same actions as the three side buttons and the top button found on the APX-7000 portable. They are as follows:

- F1** – Top-side-button (purple button) on the portable.
- F2** – Centre-side-button (with one dot) on the portable.
- F3** – Bottom-side button (with two dots) on the portable.
- F4** – Top button (orange button) on the portable.

TECHNISONIC INDUSTRIES LIMITED

TDFM-9000 Transceiver Recommended Keypad Menu Defaults:

TDFM-9000 TRANSCEIVER	PORTABLE	CONVENTIONAL OPERATION	TRUNKED OPERATION
ITEM	ITEM	ALL BANDS	ALL BANDS
F1 Key	Upper Side Button 1	Monitor	Unprogrammed
F2 Key	Middle Side Button 2	Nuisance Delete	Unprogrammed
F3 Key	Bottom Side Button 3	Talkaround/ Direct	Unprogrammed
F4 Key	Top Button	Volume Set Tone	Volume Set Tone
MUP and MDN keys	16-Position Rotary Knob	Channel Select	Talkgroup Select
ESW Key	Two-Position Concentric or Ergo Switch	Unprogrammed A (∅) Unprogrammed B (O)	Unprogrammed A (∅) Unprogrammed B (O)
TSW Key	Three-Position Toggle Switch	Blank (A) PL Disable (B) Blank (C)	Blank (A) Blank (B) Blank (C)

NOTE: It is possible to use Motorola's Customer Programming Software (APX CPS™) to alter the default keypad settings of the TDFM-9000 radio. However, if custom key settings are chosen, it will not be possible for Technisonic to help the Pilot or other Radio User through operational difficulties. These questions will have to be referred to the Radio System Administrator responsible for customizing the settings. Technisonic recommends that the default key settings stay in place until all airframe installation and operational issues have been overcome.

TECHNISONIC INDUSTRIES LIMITED

Modules 1 through 6 of the TDFM-9000 Transceiver are programmable by Motorola CPS™. The following settings may be programmed for each Conventional Channel in a module:

TX Frequency	Zone
TX PL/DPL Code	Channel
RX Frequency	Name
RX PL/DPL Code	RX Signal Voice Type
Time-Out Timer	TX Signal Voice Type
Scan List	Network Access Code
Phone Numbers	TX Power
Talkgroup IDs	Private Call Type
Encryption Key Assignment	

The following settings can be programmed for each mode in a P25 Trunked and/or SmartNet/SMART ZONE equipped radio:

System Type	TG Strapping
System ID (NAC)	Zone
Individual ID (UID)	Scan List
Coverage Type	Scan Type
Affiliation Type	Interconnect
Control Channel (s)	Phone Display Format
Talkgroups	Private Call Operation
Status	Site Alias
Encryption Key Assignment	

The function keys, along with the rest of the keypad, revert to normal number keys during transmit and when NUM LOCK is selected by pressing the rotary knob.

The F1 – F4 keys can be programmed as Hot Memory keys as mentioned in Section 2.7. Depending on the setting in the configuration menu, the keys can be permanently set to Hot Memories (channels) or used for other functions (normal). When the F1 – F4 keys are in the normal mode, they can still be used for Hot Memory Recall if the FUNC key is pressed first.

2.9 MUP(4) AND MDN(7) KEYS (Memory Up and Down Keys)

These keys provide the same function as the rotary knob does when it is set to CHAN. These keys can be used to scroll through the channels. A single press will step the channel by one, but a push and hold will scroll to a desired channel number. The function of the rotary knob is automatically set to CHAN when either of these keys is pressed.

2.10 UP(5) AND DN(8) KEYS

The keys provide the same function as the left, right, up, and down arrow keys on the portable. The UP key equates to the right arrow key and the DN is the left. These keys are used for a variety of functions, but in the normal operating mode they are used to scroll through the soft key menus.

2.11 BRT(6) AND DIM(9) KEYS

Use these keys to dim or brighten the display. The radio powers up at full brightness for normal use but can be dimmed for night operations. The display dimmer has 31 steps. If the display is at max normal brightness (31), pressing the BRT key will force the display to step 32 "Daylight" level for viewing in direct sunlight. This mode is temporary and will revert to max normal level when the key is released.

In addition, there is an Automatic Daylight Mode or 'ADM' feature. If the ADM is enabled in the configuration menu, then when the brightness is set to 31, the display will go to full daylight mode whenever a button is pressed or the knob is rotated. The display will remain in daylight mode for a period of time, then revert back to normal brightness of 31. If buttons are pressed before the timer runs out, then it will be reset. The timer can be adjusted from 1 to 10 seconds. If the timer is set to 0, the ADM feature is disabled and max brightness will only be on as long as the BRT key is pressed. If the dimmer setting is set to any level below 31, ADM will not affect the display.

2.12 ESW(0) KEY (Ergo Switch Key)

The ESW key provides the function of the concentric or 'ergo' switch on the portable. The switch has two conditions which are represented by 'O' and 'Ø'. Pressing the ESW key toggles the condition back and forth. The condition is displayed at the right hand side of the display line (second character from the right). The ergo switch condition is saved when the unit is turned off. There are separate conditions for each band installed. The ESW key can be programmed with the CPS™ to a variety of functions such as low power, scan and secure, or encrypted mode.

2.13 TSW(*) KEY (Toggle Switch Key)

The TSW key provides the function of the toggle switch on the portable. The switch has three conditions which are represented by 'A', 'B', and 'C'. Pressing the TSW key toggles the condition A,B,C,A,B, etc. The condition is displayed at the far right hand side of the display line (last character on the right). The toggle switch condition is saved when the unit is turned off. There are separate conditions for each band installed. The TSW key can be programmed with the APX CPS™ to a variety of functions such as low power, scan, zone select, or PL disabled mode.

2.14 DISPLAY

The transceiver has full colour LCD display. The zone name, channel name, condition symbols (scan, direct, call, secure, monitor, etc.), and switch settings will be displayed for each module. The active band as selected by the soft keys will be highlighted. The bottom line displays the menu items associated with the module selected and the mode of the knob.

2.15 GENERAL OPERATION

Switch on the transceiver by pressing the knob. Select the desired band by pressing one of the band select keys on the left of the display. Select the TDFM-9000 on the aircraft audio panel. Press the knob again so that CHAN shows up on the bottom right of the display. Rotate the knob until the desired channel or talk group is selected. Press the knob until VOL is again shown on the display. You can adjust the volume by waiting until a signal is received or by pressing F1 (factory programmed for monitor function) and adjusting the rotary knob. The radio is ready to use. If the radio is installed in separate mode, remember that the band selected by the soft keys is what menu is displayed on the screen but the band selected by the audio panel is the band that you are transmitting and receiving on. To use the DTMF keypad while transmitting, the band you are using must be selected on the display. If the radio is installed using both of the combined input/outputs, then pressing the MODE key will alternate the display between the two users. Pushing and holding the bottom side menu key will toggle the Main Screen to show the External Transceivers or S200-P12 controls (MOD 14 radios only).

2.16 PROGRAMMING SOFTWARE

APX CUSTOMER PROGRAMMING SOFTWARE (APX CPS™)

Programming the Bands in the TDFM-9000 is usually done with the use of third party programming software. Customer programming software, or “APX CPS,” must be supplied by Motorola. However, conventional analog or P25 channels can be programmed at the front panel if each module is fitted with the Front Panel Programming option (FPP). See Section 2.19 for details.

A Programming cable “PC-9000” is required to connect the computer to the TDFM-9000. Bands 1 - 6 in the TDFM-9000 are considered an APX portable by the APX CPS™ software. To program a band in the transceiver, it must be selected by pressing the appropriate band select key before running the APX CPS™. Follow the instructions supplied with the APX CPS™.

The APX CPS Programming software (P/N HKVN4289 - SW download) must be purchased from Motorola On Line (MOL). Alternately a DVD can be ordered (P/N RVN5224) via MOL.

For instructions on ordering Motorola parts and APX CPS software, see Technical Information Bulletin TIBFM 17-01.

This document is available on the Technisonic website at www.til.ca. On the main page, hover the cursor over “Project 25 Airborne FM.” A pull-down menu should appear. Click the TDFM-9000 link to go directly to the TDFM-9000 page and click the link for “APX CPS Programming Software/Cables Ordering Guide.” Refer to the section for Type “A” modules.

If encryption keys need to be loaded via a KVL-3000+ or KVL 4000, a keyloader cable P/N 127500 may be also be obtained from Technisonic. This keyloader cable will plug into the front mini DIN connector of the TDFM-9000 transceiver.

The following cables for support of the TDFM-9000 can be purchased from Technisonic:

P/N 127499 Download/Programming Cable (See Figure 2).

P/N 127500 Encryption Keyload Cable (See Figure 3).

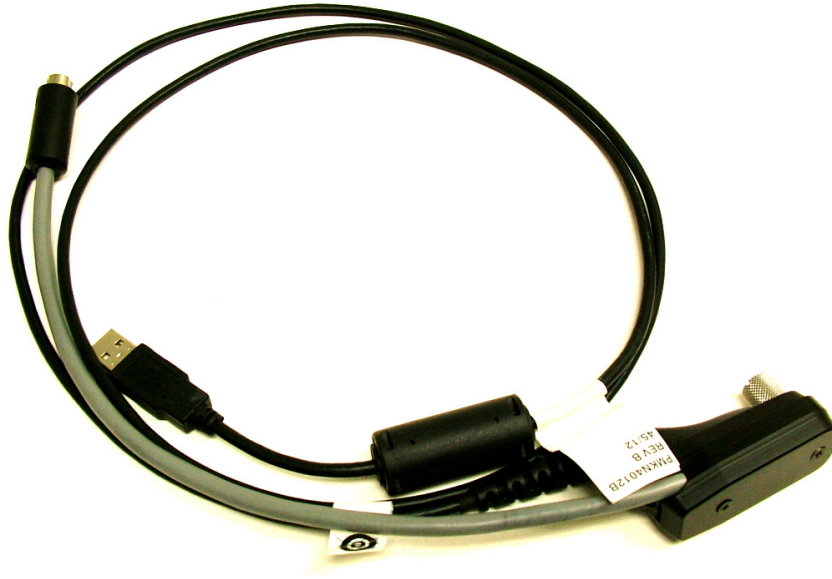

FIGURE 2: Programming Cable: "PC-9000" P/N 127499

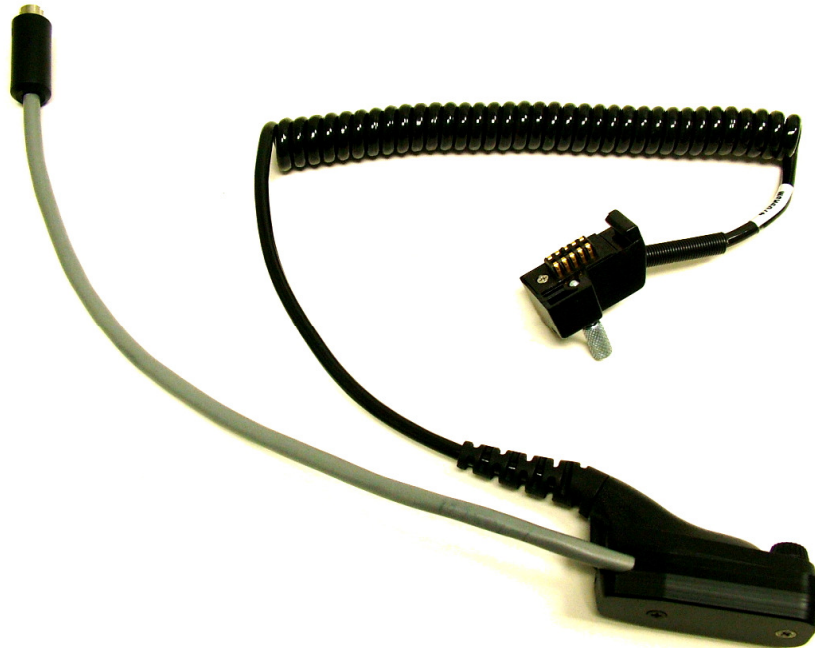

FIGURE 3: Encryption Keyloading Cable: "KVL-9000" P/N 127500

2.17 CONFIGURATION MENU

Some features of the TDFM-9000 transceiver can be configured to the user's preference. To enter the configuration menu, press the FUNC button, then NEXT, and then select "Configuration" from the 2nd side button. Select the Item by pressing the side button. Rotate the knob to select the desired condition. Press the "NEXT" soft key to access the next page of configuration items. Press "ESC" Soft key to exit Configuration at any time.

NOTE: The Configuration Menu maybe disabled via the Supervisor Menu. Consult TIL or the local System administrator if changes are required.

The following menu items can be changed or modified:

<i>Knob Default</i>	This will select which mode (volume or channel) the knob will be when the radio is first turned on.
<i>Vol/Chan Mode</i>	When set to both, volume and channel functions are both available. If set to single, only the function set in the above knob default will be available.
<i>Num Lock Mode</i>	Num Lock Mode changes the keys to a numeric keypad. Num Lock can be set to Disabled, Enabled, Revert, or TMR Revert. When enabled, the Num Lock mode is available by pressing the Channel Knob. The knob mode will remain in Num Lock until the knob is pushed again. When set to Revert, and the knob is pressed to select Num Lock, the mode will wait until a number key is pressed, then the knob mode will revert to its preset default. If Num Lock is set to TMR Revert, the same is true as Revert, except the mode returns to its default after a preset timer.
<i>Recall Mode</i>	When enabled, recall of a Zone and Channel is added to the available knob functions. Recall can be configured to recall ZONE only, CHAN only, or NORMAL for both.
<i>Backlighting</i>	Select 28 volts DC or 5 volts AC. No damage will occur if the wrong setting is made. Toggling this side key will allow independent backlight setting for the RC-9000 if connected.
<i>F1 – F4 keys</i>	If set to normal, the keys will emulate the side buttons on the portable. If set to channels, the keys become quick channel load keys. The channels can be programmed in the second function menu.
<i>Dual User Mode</i>	Set to enabled when the radio is installed with both combined ports connected.
<i>Always On Mode</i>	When enabled, the radio turns on and off with the aircraft radio master.
<i>CSQ Indicator</i>	Toggles the CSQ Indicator  on or off. Default is on.
<i>Hi/Lo power Indicator</i>	Toggles the HI/LO Indicator  on or off. Default is on.
<i>ESW Indicator</i>	Toggles the ESW Indicator  on or off. Default is on.

TECHNISONIC INDUSTRIES LIMITED

<i>TSW Indicator</i>	Toggles the TSW Indicator A/B/C on or off. Default is on.
<i>Sidetone Level</i>	Sets the sidetone level. The microphone and headphone audio become live while in this mode to facilitate setting to a comfortable level. When External transceivers are enabled on the MOD 14 Radios, a second screen is available for adjustment.
<i>Squelch Blink</i>	When disabled, the squelch indicator lights will function normally. When enabled, the receive squelch lights will stay lit while a signal is present and then blink for a couple of seconds after the signal disappears. This can help to determine which band made the last call.
<i>TMR Revert</i>	This menu sets the time from 1 to 10 seconds for Num Lock Mode to revert to the knob default (applies only if Num Lock set to TMR Revert).
<i>Recall TMR Revert</i>	This menu sets the time from 1 to 10 seconds for Recall Mode to revert to the knob default. If set to 0, then Recall Revert is disabled.
<i>ADM Timer</i>	This menu sets how long the display max brightness remains on whenever a button is pressed or the knob is rotated when the Automatic Daylight Mode (ADM) is enabled. A value from 1 to 10 seconds can be set before the display brightness reverts back to normal dim level of 31. If the Timer is set to 0 then the ADM function is disabled.
<i>Alt Menu dir</i>	This item allows for reversing the direction of the Knob when using the alternate menu list like Zone, Chan TG, etc. Default is CW.
<i>User Mode</i>	This setting allows the operator to lock the user setting to either USER 1 or USER 2. Dual User must be enabled. Set to LOCK to prevent the user mode to be changed by the MODE key. If set to UNLOCKED, the user mode can be toggled by the MODE key.
<i>Mute Indictor</i>	This menu item allows for disabling the Mute "X" Indicator when the radio is wired in separate mode.
<i>RFM Text Colour</i>	This menu allows the user to independently change the text colour of each RF module installed in the radio. Select the desired module then rotate the knob to select colour. A second page is provided for MOD 14 radios with the External transceivers enabled.

TECHNISONIC INDUSTRIES LIMITED

Ext Transceiver 1

This menu enables the External Transceiver # 1 connections. If an external portable radio is connected, audio and PTT is routed through the TDFM-9300 radio. The External radio can be used as an additional 7th module with no display. Set to "Enabled" to activate the radio port.

Ext Transceiver 2

This menu enables the External Transceiver # 2 connections. If an external portable radio is connected, audio and PTT is routed through the TDFM-9300 radio. The External radio can be used as an additional 8th module with no display.

In addition, this module can be set to S200-P12 mode. This will provide remote control on the TDFM-9300s screen of the Latitude S200-P12 Satellite radio if connected to the # 8 port.

Set to "Enabled" to activate the Standard radio port. Set to "S200" to configure this port to Latitude mode.

Press the ESC button to exit configuration mode. The radio will return to normal operation display. The radio will keep these settings until they are changed again in the configuration menu.

2.18 KEYLOADING MODE

Press the ESC button to exit configuration mode. The radio will return to normal operation display. The radio will keep these settings until they are changed again in the configuration menu.

If the TDFM-9000 is equipped with hardware encryption, then the Encryption keys will need to be loaded using a Motorola KVL 3000+® or KVL 4000/ KVL 5000 Keyloader and a KVL-9000 cable, (TiL P/N 127500).

Modules in the TDFM-9000 can easily be keyloaded by simply selecting the band and plugging in the keyloader and cable into the programming connector on the front of the radio.

Turn on the keyloader and connect the cable to the TDFM-9000. The selected band will display "KEYLOADING". Follow the Motorola Keyloader instructions for uploading the actual keys to the radio.

If other bands require keys, press the next soft key to select the next module, wait 1 second for the module to sense the keyloader, and then upload the key(s).

When keyloading is done, remove the keyloader cable. The module will resume normal operation.

2.19 FRONT PANEL PROGRAMMING (FPP) MODE

Some type “A” and some type II modules have the capability to program channel information such as frequencies, PL tones, modulation types, etc. from the front panel. ‘FPP’ will show up as one of the soft menu items at the bottom of the screen if this option has been ordered. When the FPP soft key is pressed, the following screen will appear:

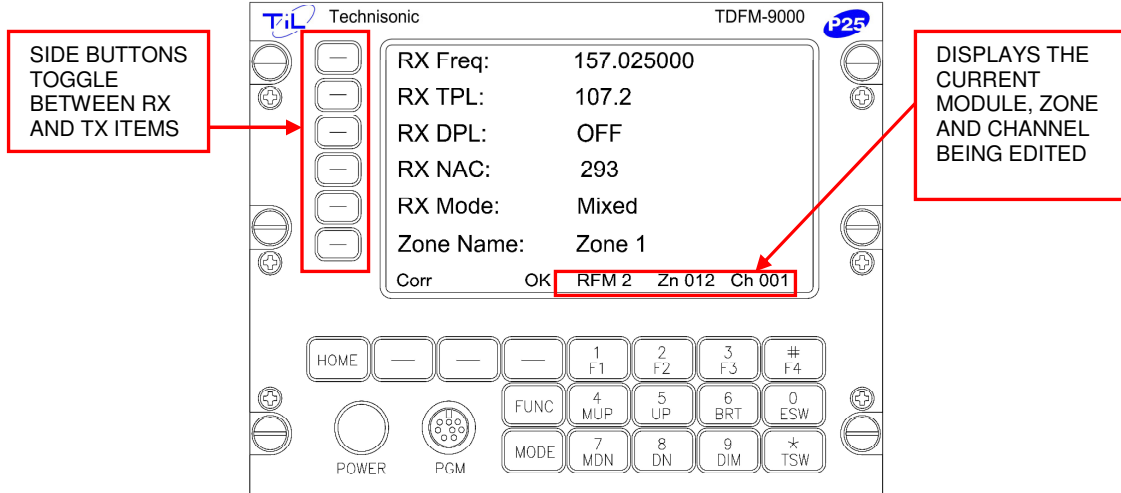

The display shows all of the information contained in the current channel. Pressing one of the side menu keys will select the attribute to be edited. Toggling between transmit and receive can be done by either pressing the menu key again or by pressing the knob with the exception of the Name line which toggles between Zone Name and Channel Name. Toggle the RX NAC/TX NAC key to access the Talkgroup ID menu.

RX/TX Freq.

The RX and TX frequencies can be changed by entering a new value via the keyboard. After entering the RX frequency press the OK soft key. The menu will prompt for a TX Freq. Push the top side button to manually toggle between RX and TX frequencies.

RX/TX TPL

Rotate the knob to scroll through the available RX TPL (CTCSS tones). Press the OK soft key to accept. The menu will prompt for a TX TPL tone. Rotate the knob to select. Press Ok to accept. The second side button also toggles between the RX and TX TPL codes. TPL tones cannot be programmed if DCS codes are already active.

RX/TX DPL

Rotate the knob to scroll through the available RX DPL (DCS codes). Press the OK soft key to accept. The menu will prompt for a TX DPL code. Rotate the knob to select. Press Ok to accept. The third side button also toggles between the RX and TX DPL codes. DPL tones cannot be programmed if TPL tones are already active.

RX/TX NAC

Enter the desired NAC via the keyboard. The Network Access Code is a hex number between 000 and FFF. The standard number is 293. The middle soft menu key will allow toggling between 0-9 and A-F. In A-F mode the number keys 1-6 program A- F. Programming a NAC code on an analog channel has no effect.

TECHNISONIC INDUSTRIES LIMITED

- Talkgroup ID** Toggle the 4th side button 2 times to enter the desired Talkgroup ID via the keyboard. The Talkgroup ID is a hex number between 0001 and FFFF. The default number is 0001. The middle soft menu key will allow toggling between 0-9 and A-F. In A-F mode, the number keys 1-6 program A-F. Talkgroup ID is only used when the channel is programmed to transmit in digital mode.
- RX/TX Mode** Rotate the knob to scroll through Analog, Digital (P25), or Mixed. When the RX mode is set to Analog then the TX mode is automatically set the same. If the RX mode is set to Digital then TX Mode is also Digital. If the RX mode is set to Mixed, then the TX Mode can be set to either Analog or Digital. If the RX mode is set to mixed, then this channel will receive both Analog and Digital based on the TPL/DPL and NAC/Talkgroup criteria. The fifth side button toggles between the RX and TX Mode.
- Zone/Channel Name** Rotate the knob to scroll through the available characters. Press the NEXT soft key to get to the next position. Pressing NEXT at the end of the name will loop back to the first character position. Press OK to save and toggle to the Channel Name. Limit the Zone Name to 8 characters and the Channel Name can accept up to 14. The bottom side button toggles between the Zone Name and Channel Name.

After editing any parameter press the OK soft key to accept the changes. The next item will be highlighted upon pressing the OK key. Press the HOME key to save your current changes and return to normal operating mode.

FPP can only be used on a memory containing a conventional Analog or conventional P25 Digital channel. P25 Trunked or Motorola Trunking channels can only be programmed via APX CPS software.

NOTE: The FPP mode will only accept changes if the channel is in a Zone that is FPP enabled in the codeplug. If the channel is in a Zone that is not enabled for FPP, the channel data will be displayed but no changes will be accepted.

TECHNISONIC INDUSTRIES LIMITED

The following is a list of supported TDFM-9000 TPL (CTCSS) Codes:

PL (Hz)	MCODE	PL (Hz)	MCODE	PL (Hz)	MCODE	PL (Hz)	MCODE
67.0	XZ	97.4	ZB	141.3	4A	206.5	8Z
69.3	WZ	100.0	1Z	146.2	4B	210.7	M2
71.9	XA	103.5	1A	151.4	5Z	218.1	M3
74.4	WA	107.2	1B	156.7	5A	225.7	M4
77.0	XB	110.9	2Z	162.2	5B	229.1	9Z
79.7	WB	114.8	2A	167.9	6Z	233.6	M5
82.5	YZ	118.8	2B	173.8	6A	241.8	M6
85.4	YA	123.0	3Z	179.9	6B	250.3	M7
88.5	YB	127.3	3A	186.2	7Z	254.1	OZ
91.5	ZZ	131.8	3B	192.8	7A	CSQ	CSQ
94.8	ZA	136.5	4Z	203.5	M1		

TABLE 1: TDFM-9000 Series TPL (CTCSS) Codes

The following is a list of TDFM-9000 DPL (DCS) CODES:

023	072	152	244	343	432	606	723
025	073	155	245	346	445	612	731
026	074	156	251	351	464	624	732
031	114	162	261	364	465	627	734
032	115	165	263	365	466	631	743
043	116	172	265	371	503	632	754
047	125	174	271	411	506	654	
051	131	205	306	412	516	662	
054	132	223	311	413	532	664	
065	134	226	315	423	546	703	
071	143	243	331	431	565	712	

TABLE 2: TDFM-9000 Series DPL Codes (All Bands)

Notes:

2.20 LATITUDE S200-P12 SATCOM CONTROL

External Transceiver #2 (Band 8) can also support the Latitude Technologies S200-P12 Satellite Communications System.

When the S200-P12 is connected, Band 8 becomes the controller. The Latitude S200-P12 provides the following services:

- GPS position reporting
- Iridium messaging
- Iridium satellite phone
- PTT communications network

The S200-P12 can be in one of two modes: PTT or Phone mode. The S200-P12 can be configured to always start up in one or the other mode. In PTT mode, only PTT network communications can occur. In Phone mode, position reporting, messaging, and SATPhone communications can occur.

2.21 LATITUDE S200-P12 PTT MODE

In PTT mode, the display will show 'SATPTT' followed by the channel name. There are up to 15 channels available. The second line is the status line followed by the menu / knob function line.

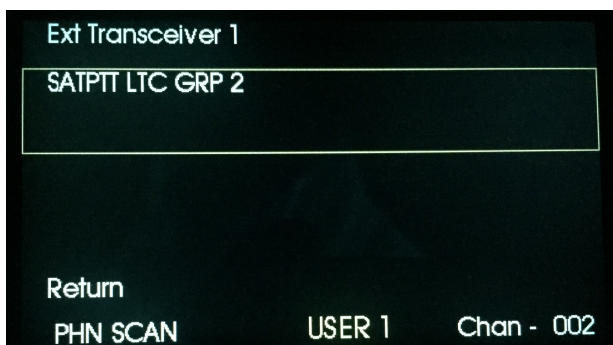

To transmit, key the PTT in the usual manner and wait. The display will initially show 'TX Pending' on the status line. If a connection is made, the acceptance tones will be heard and the status line will show 'TX Granted' along with an illuminated TX LED on the top right of the display.

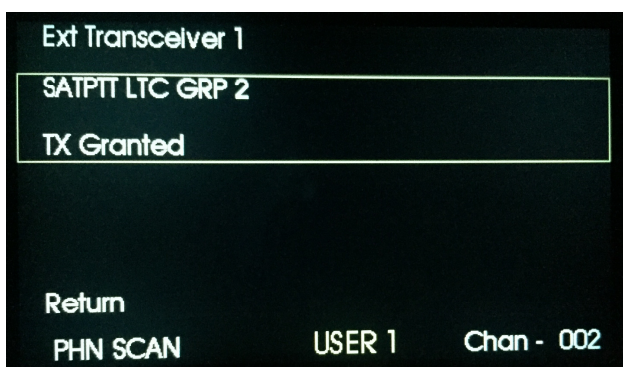

At this point, you may speak normally. Transmit time is limited to 20 seconds. If transmit time runs out or connection is lost for any reason, you will hear the disconnect tones. Transmit may not be granted if there is no signal, the channel is busy, or the selected channel is not authorized for use. The reason will be displayed on the status line. During receive, the squelch LED on the top left of the display will illuminate and the caller ID, direction, and distance will be shown on the status line.

TECHNISONIC INDUSTRIES LIMITED

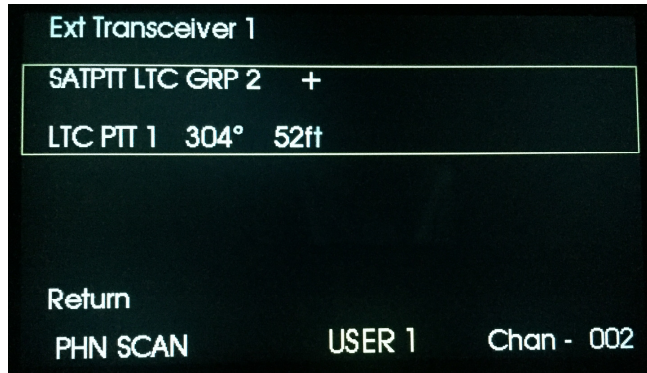

Any or all of the channels can be put into a scan list and scanned. To edit the scan list, press the SCAN soft key. By selecting the desired channels with the knob and pressing the +/- soft key, channels can be added or removed from the scan list. Selected channels will display a '+' at the end of the channel name on the top line.

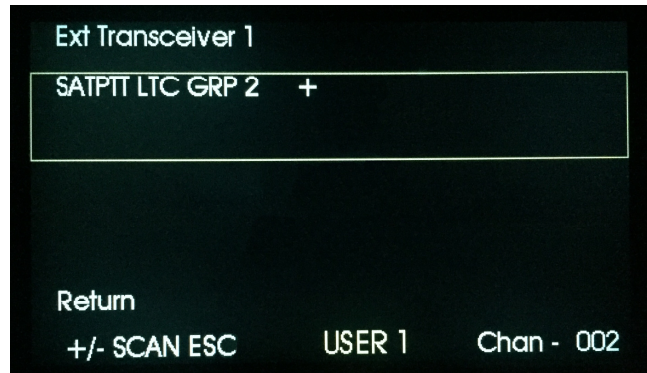

To scan the selected channels, press the SCAN soft key. The channel name will show as 'SCANNING.' Press the STOP soft key to stop.

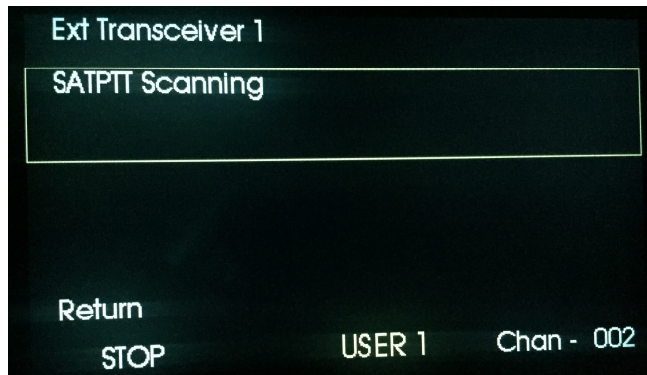

2.22 LATITUDE S200-P12 PHONE MODE

In PTT mode, pressing the PHN soft key will switch the S200-P12 into phone mode. The display will show 'SATPhone' followed by blank spaces or the last phone number entered.

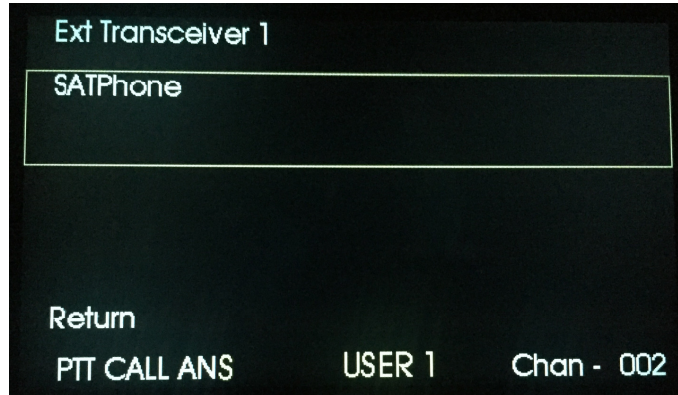

An incoming call can be answered by pressing the ANS soft key. There is also ringtone heard in the headset which is useful if the TDFM-9100 is on another band. To make a call, a phone number can be entered directly from the keypad or retrieved from the S200-P12 built-in phone book. To access the phone book, press the CALL soft key and then the PBK soft key.

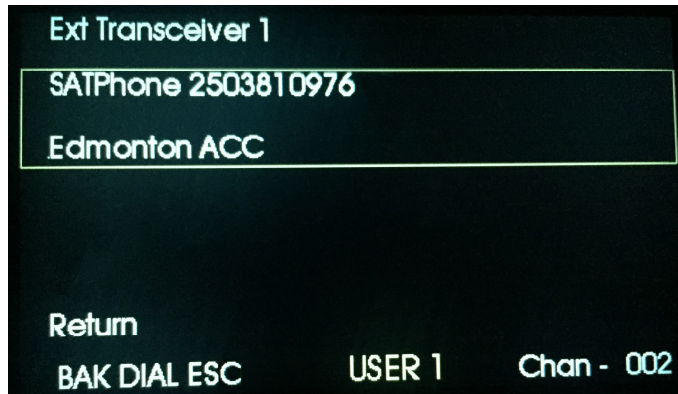

Press the DIAL soft key to dial the number. When finished with the call, press the HUP soft key to hang up. Phone mode also supports text messages to be sent through the Iridium system. These are not the same as normal phone text messages and can only be sent to the dispatcher. The TDFM-9000 can save and recall up to ten commonly used messages.

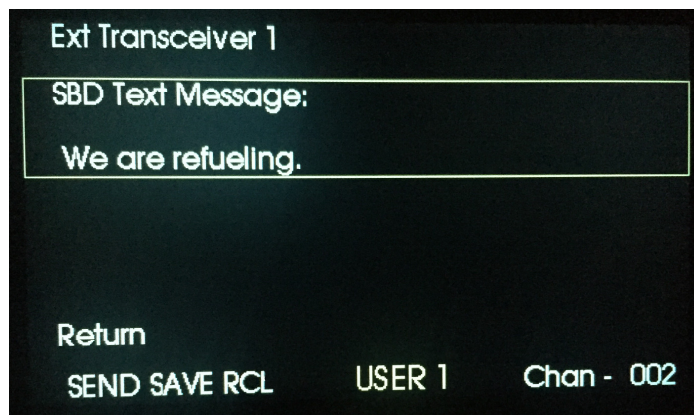

TECHNISONIC INDUSTRIES LIMITED

To enter a message, press the CALL soft key and then the TXT soft key. Turning the knob will scroll the first character through the alphabet, numbers, and symbols until the desired character is reached. Pressing the knob advances the cursor to the next position. Continue until your message is complete and press SEND. If you want to save the message first, press SAVE and a memory number from 0 to 9. When a message is received by the S200-P12, it will be displayed on the status line until confirmed by pressing the ESC soft key. Another message may be waiting in the queue. When there are no more messages, the display returns to the normal SATPhone screen. While in this screen, you can return to PTT mode by pressing the PTT soft key.

TECHNISONIC INDUSTRIES LIMITED

Technisonic Industries Limited

240 Traders Blvd., Mississauga, ON Canada L4Z 1W7

Tel: (905) 890-2113 Fax: (905) 890-5338

**IMPORTANT
WARRANTY**

All communication equipment manufactured by Technisonic Industries Limited is warranted to be free of defects in Material or Workmanship under normal use for a period of one year from Date of Purchase by the end user.

Warranty will only apply to equipment installed by a factory approved and/or authorized facility in accordance with Technisonic published installation instructions. Equipment falling under the following is not covered by warranty:

- Equipment that has been repaired or altered in any way as to affect performance
- Equipment that has been subject to improper installation
- Equipment that has been used for purposes other than intended
- Equipment that has been involved in any accident, fire, flood, immersion, or subject to any other abuse.

Expressly excluded from this warranty are changes or charges relating to the removal and re-installation of equipment from the aircraft. Technisonic will repair or replace (at Technisonic's discretion) any defective transceiver (or part thereof) found to be faulty during the Warranty Period.

Faulty equipment must be returned to Technisonic (or its authorized Warranty Depot) with transportation charges prepaid. Repaired (or replacement) equipment will be returned to the customer with collect freight charges. If the failure of a transceiver occurs within the first 30 days of service, Technisonic will return the repaired or replacement equipment prepaid.

Technisonic reserves the right to make changes in design, or additions to, or improvements in its products without obligation to install such additions and improvements in equipment previously manufactured. This Warranty is in lieu of any and all other warranties express or implied, including any warranty of merchantability or fitness, and of all other obligations or liabilities on the part of Technisonic.

This Warranty shall not be transferable or assignable to any other persons, firms, or corporations.

**For warranty registration, please complete the online
Warranty Registration Form found at www.til.ca.**